

2021

OUTDOOR / SWIMMING POOL / SAUNA



WWW.GIGACER.IT

INDEX

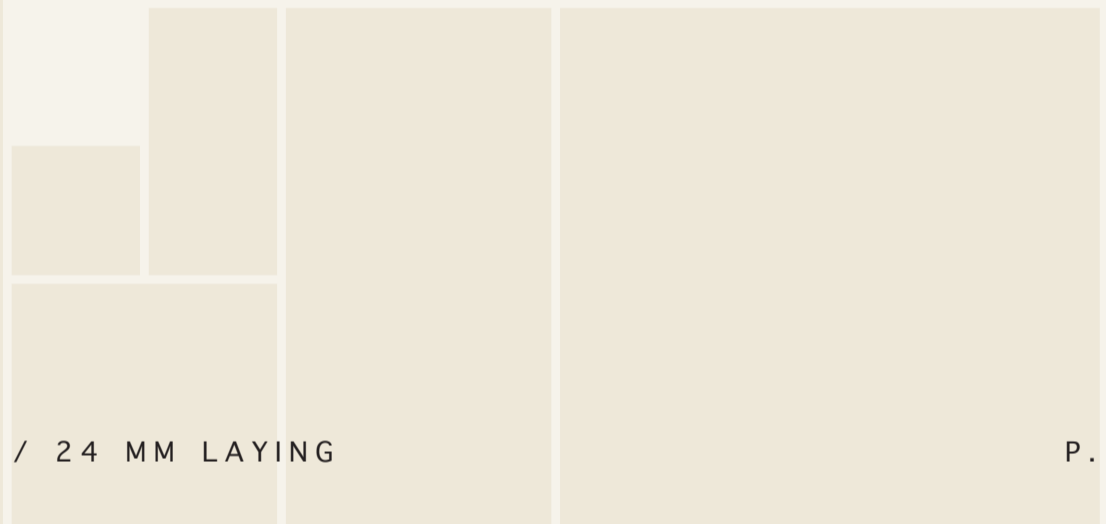
	
12 / 24 MM LAYING	P. 3
CONTINUITY BETWEEN INDOORS / OUTDOORS	P. 4
OUTDOOR COLLECTIONS	P. 5
≠ 24 MM	P. 10
≠ 24 MM SPECIAL TRIMS	P. 13
PROJECTS	P. 14
TECHNICAL FEATURES	P. 29



laying

#12 mm



#24 mm



1

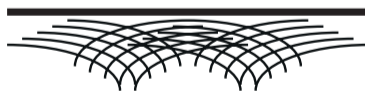

Laying on glue

2

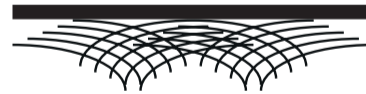

Laying on glue

3



Dry installation on gravel

4



Dry installation on grass

5



Polypropylene supports

12 MM / 24 MM - INDOOR / OUTDOOR

Perfect continuity between indoors and outdoors



FIND OUT
OUR OUTDOOR SERIES

CONCEPT 1

INCLUSIONI

MADE 2.0

QUARRY

**GIGACER
OUTDOOR
SERIES**



All in one

Concept 1 is to conceive space with unity of form and style, using technical solutions that maintain aesthetic continuity through the environments and their multiplicity of uses, indoors, outdoors, on walls and furniture, in short: all in one. A unique ceramic range designed for every type of application, with a variety of colours and surfaces that can always be combined in an exclusive and personal way. A resistant, eclectic porcelain stoneware in natural and homogeneous shades, with 5 colours, 5 different surfaces and 3 thicknesses.

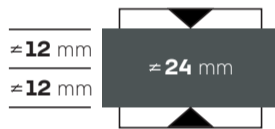

CONCEPT 1



MILK

STONE

ASH

LAND

INK



A meeting between contemporary aesthetics and timeless elegance. The power of time which amalgamates and smoothes surfaces: the elegance of the series Inclusioni. Inspired by the force of the nature, Inclusioni is an encounter between contemporary aesthetics and timeless elegance. Surfaces are authentically material and refined: porcelain stoneware flakes produced under the skilful control of our laboratory technicians are deposited on the surface and incorporated; the result is a tangible and three-dimensional effect.

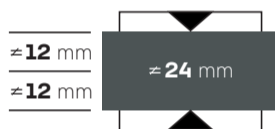

INCLUSIONI



BIANCO PERLA

ECRÙ

TABACCO

CENERE

VULCANO



Made 2.0, in synergy with Concrete, is a flexible ceramic system used for living spaces. It is the most complete color / surface combination palette in neutral and natural shades: eleven colours and four different surface that could be adapted to the different needs of living. The same colour could be used from the indoor to the outdoor, in floors and covering and for the creation of kitchen tops and bathroom furniture while maintaining a strong chromatic coherence. All the Made 2.0 Palette corresponds to the Concrete colours. The White Sand colour can be combined with the Concrete White.

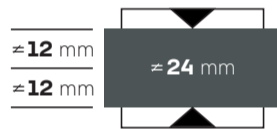

MADE 2.0



ICE

ROPE

GREY

IRON

SMOKE

GRAPHITE

BROWN

MUD

BEIGE

DUST

SAND



antislip R11 A + B + C

The best choice for nature

In strict respect for the environment typical of Gigacer, a series inspired by the solidity and strength of natural stone. Quarry offers great versatility: with its numerous formats and two different surfaces, mat R10 A+B and bocciardato antislip R11 A+B+C, it is suitable for both indoor and outdoor, residential and business contexts.

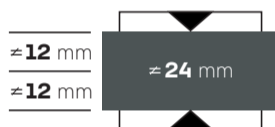

QUARRY



QUARZITE BIANCA

ARENARIA

GRAVEL STONE

CREMA MARFIL

GOLDEN STONE

LAVA STONE

#24 mm
flooring
system for
outdoor
using

**# 24
mm**

24 mm system and the special antislip (R10 or R11 with A+B+C) surface guarantee high technical performances as well as remarkable safety for outdoor pedestrian use.

24 mm system is frostproof, inabsorbent, easy to clean, has very high resistance to impact, abrasion and to chemical aggressions.

≠24 mm consists of two standard porcelain stoneware slabs joined together. Porcelain stoneware slabs are joined by a two-components glue, obtaining a monolithic solidity. Thus linked, the two ceramic elements are then duly rectified to ensure precise and regular size to the slabs.

24mm system ensures that rain water regularly flows away thus preventing any stagnation.

≠24 MM IS THE PROFESSIONAL FLOORING SYSTEM FOR OUTDOOR LAYING MADE BY GIGACER.

24 mm offers:

- Possibility to have the same product for the indoor and the outdoor spaces
- Big format 120x120 24 mm thickness
- Possibility to have an antislip material for the outdoor R11
- Efficace drainage
- Dry laying
- Endurance and strength
- Cleanability
- Frost resistance

Laying suggestions:

- Open terraces
- Closed terraces
- Walkways
- Swimming pools
- Gardens

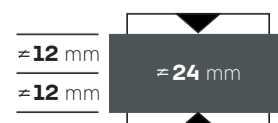

Polipropylene supports

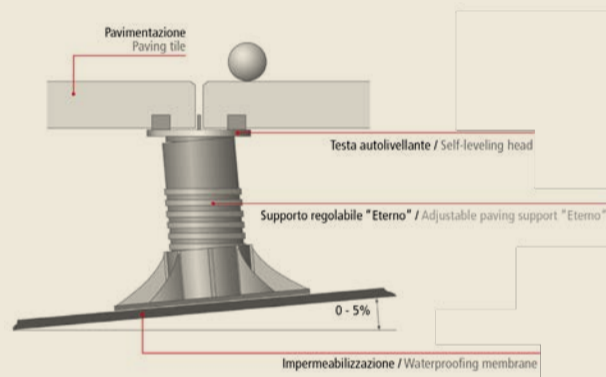
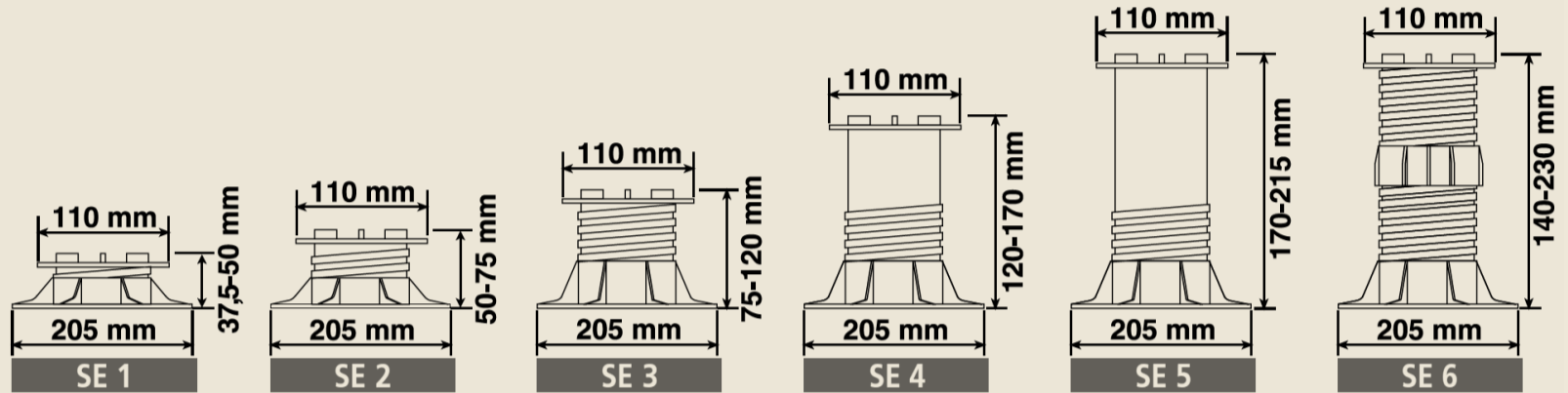
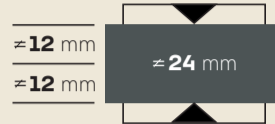
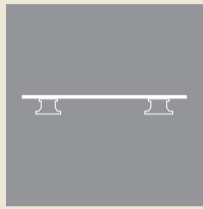

<p>120x120 3 pz/mq 9 pz/lastra</p>	<p>60x120 3 pz/mq 6 pz/lastra</p>	<p>60x60 3 pz/mq 4 pz/lastra</p>
<p>80 kg</p>	<p>40 kg</p>	<p>20 kg</p>

Outdoor special trims

#24mm Pool's edge bespoke size (up to 119) Bocciardato multilayer

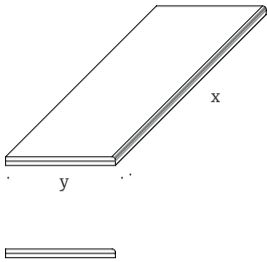

#24mm Grid-like

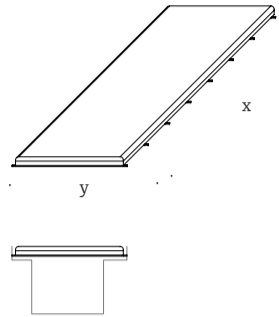

#24mm Grid-like

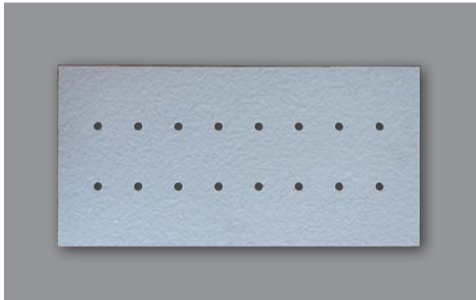
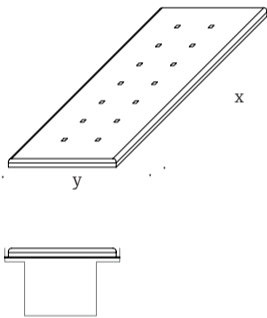

#12mm Bespoke size costa retta step

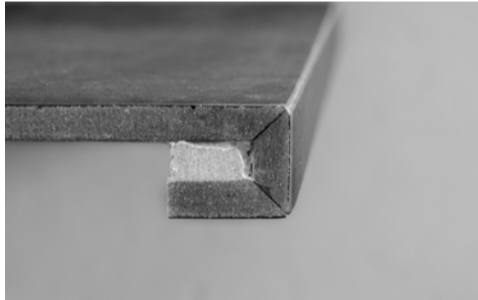
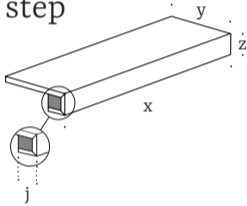

#12mm Vela step

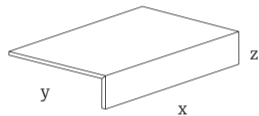

#24mm Vela step

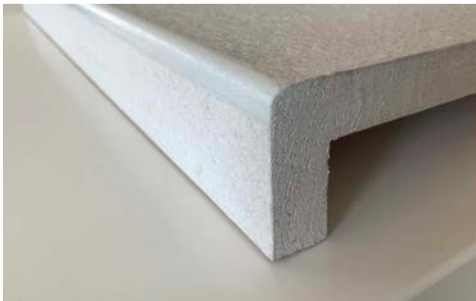
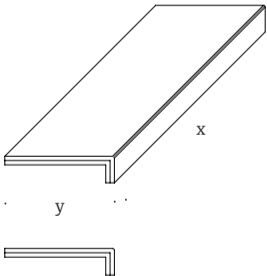

Shower trays - assemblato

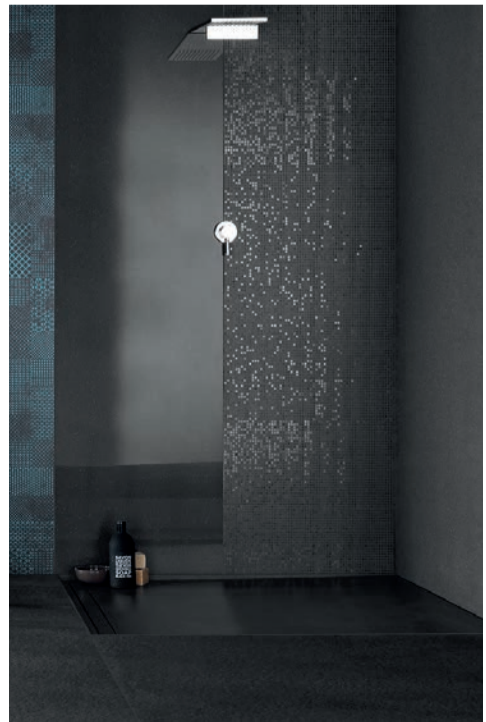
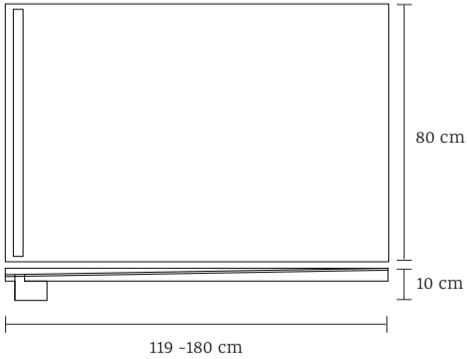

PROJECTS

PRIVATE

PUBLIC

**GIGACER
PROJECTS**



PRIVATE VILLA

Inclusioni Soave
Tabacco
Bocciardato R11
60x60 cm

Inclusioni

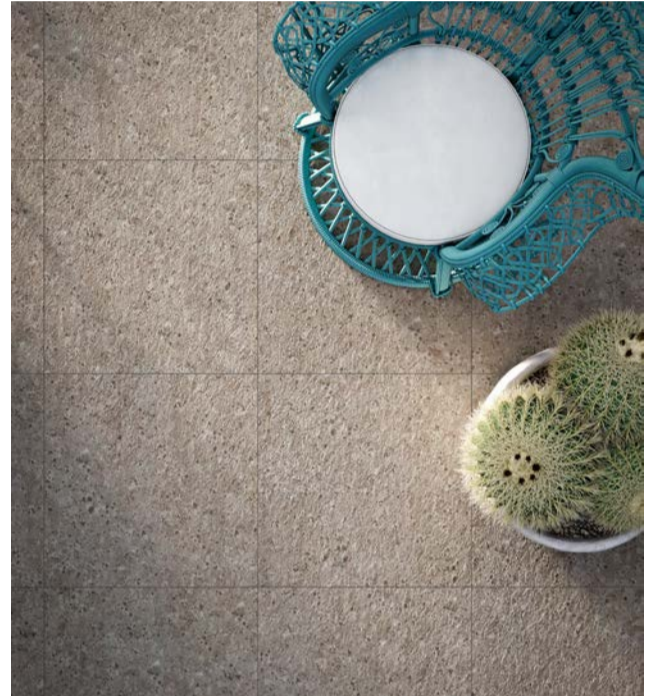

**Outdoor
Inclusioni
Soave
Tabacco
Bocciardato R11
60x60 cm**

Indoor Inclusioni Soave Tabacco Soft 120x120 cm



PRIVATE RESIDENCE

Made 2.0
Ice
Bocciardato
120x120 cm

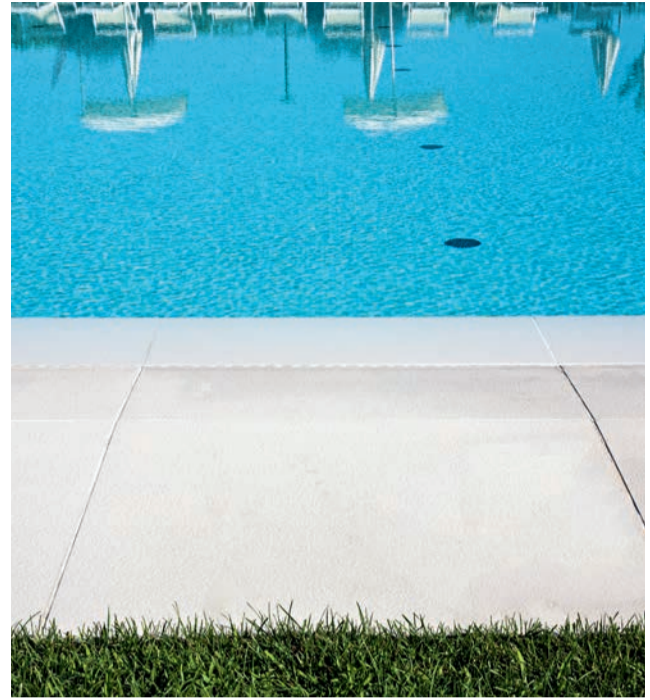

Outdoor
Swimming
Pool
Made 2.0
Ice
Bocciardato R11
120x120 cm

|

PRIVATE HOUSE

Made 2.0
Graphite
Bocciardato R11
60X60 cm



|
Made 2.0



**Outdoor
Terrace
Made 2.0
Graphite
Bocciardato R11
60x60 cm**

Indoor Made 2.0 Graphite Mat 120x120 cm

PRIVATE COTTAGE

Concept 1
Stone
Bocciardato R11
120x120 cm



Concept 1



**Private
Outdoor
Concept 1
Stone
Bocciardato R11
120x120 cm**

Wall

Concept 1 Stone Bocciardato R11 / Levigato Blend 5-10-15x60 cm

Concept 1 Stone Texture Levigato 120x250 cm

Indoor floor

Concept 1 Stone Bocciardato R10 120x120 cm

PUBLIC RESORT

Made 2.0
Sand / Brown
Bocciardato
120x120 cm

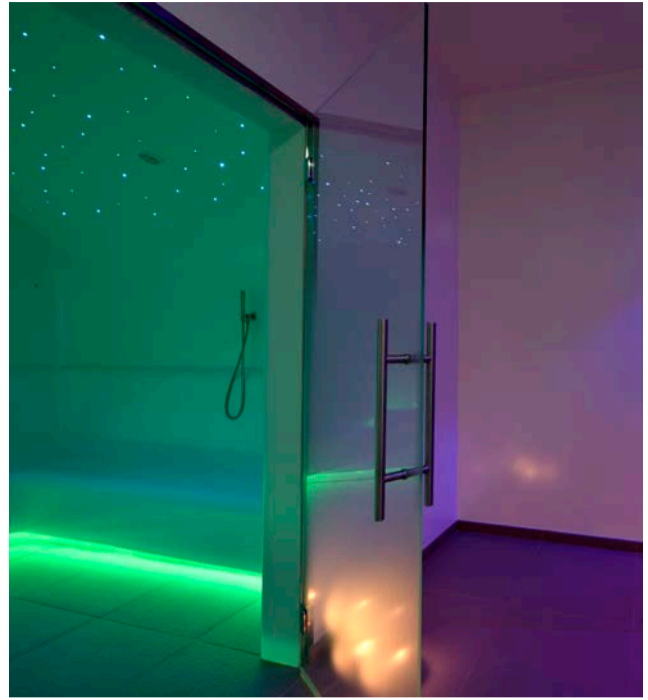
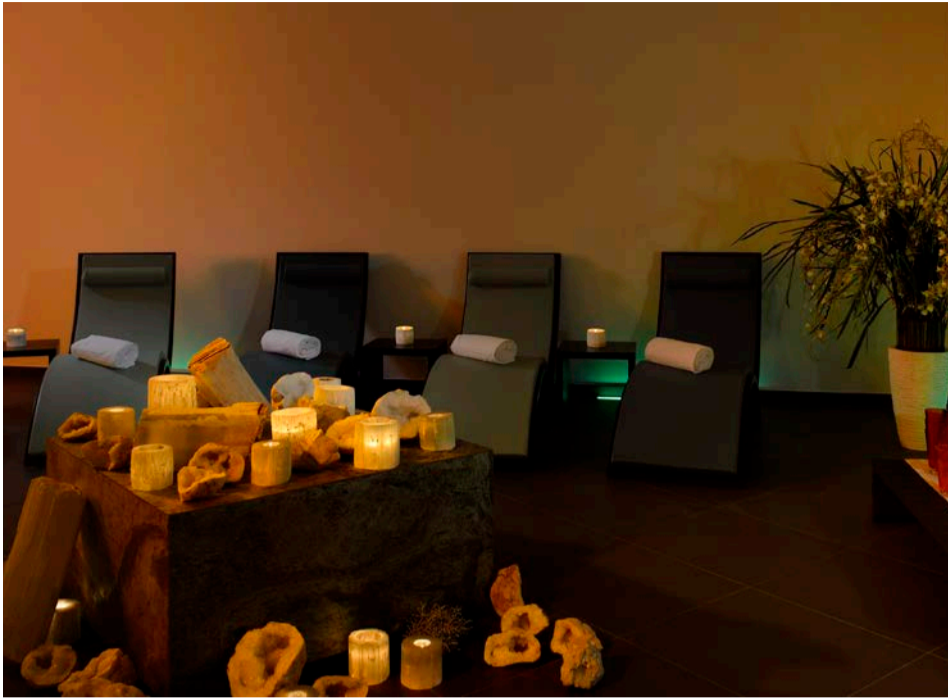

Indoor
Pool
Made 2.0
Sand
Bocciardato R11
120x120 cm

Sauna Made 2.0 ice Bocciardato R11 60x60 cm

Relax Area Made 2.0 Brown Bocciardato R11 60x60 cm



**PUBLIC
WELLNESS**

Made 2.0
Sand
Bocciardato R11
60x120 cm

|
Made 2.0

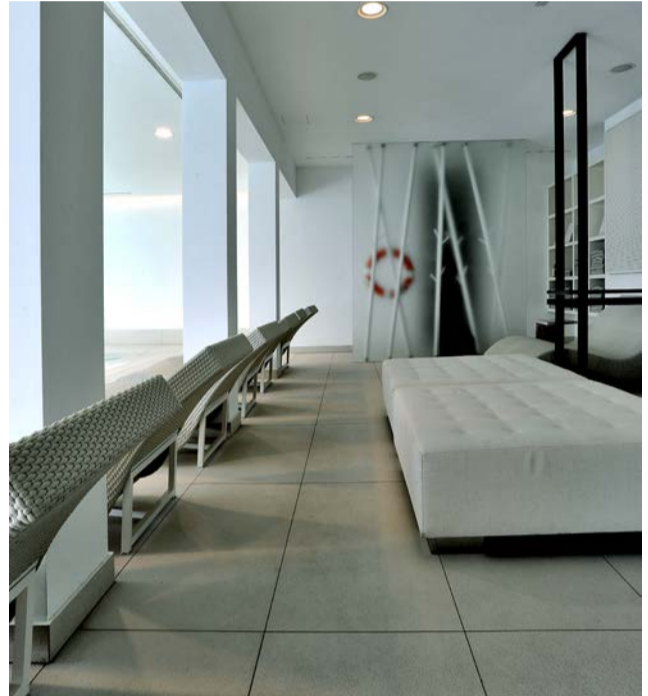

**Private
Swimming
Pool
Made 2.0
Sand
Bocciardato R11
60x120 cm**

A photograph of an outdoor dining set on a balcony. The set includes a dark brown wooden table and four matching chairs with light beige cushions. The table is rectangular with a slatted top. The chairs have a classic design with curved backs and armrests. The balcony is paved with light-colored tiles. In the background, there are several potted plants, including a large green bush and a smaller plant with pink flowers. A white patio umbrella is partially visible at the top of the frame. The overall scene is bright and inviting.





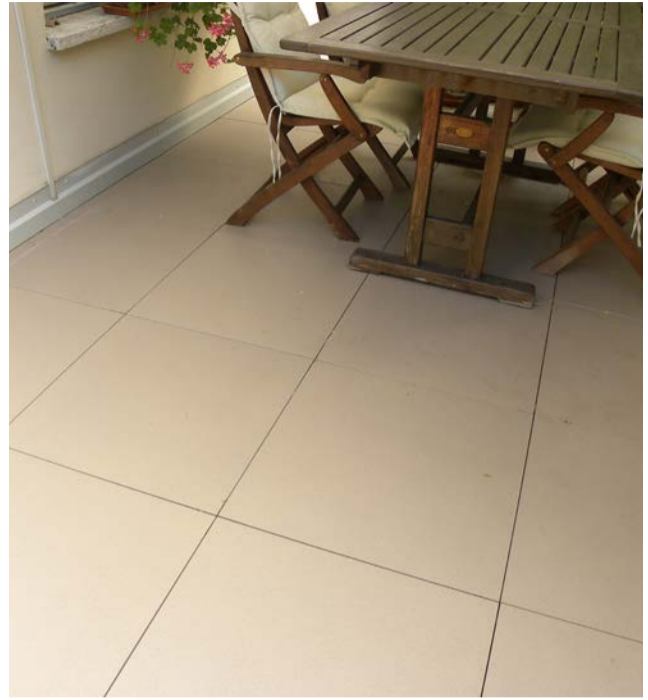









PUBLIC CHALET

Made 2.0
Beige
Bocciardato
60x60 cm
#24 mm



Terrace
#24 mm
Made 2.0
Beige
Bocciardato R11
60x60 cm

Technical features

PORCELAIN SLABS					
ISO 13006 - G - BIa UGL (E ≤ 0,5%) UNI EN 14411 - G -					
	CARATTERISTICHE TECNICHE TECHNICAL SPECIFICATIONS	NORMA ISO STANDARD	SPESSORE THICKNESS	VALORI PRESCRITTI DALLE NORME INTERNATIONAL STANDARDS	VALORE MEDIO GIGACER AVERAGE GIGACER VALUE
	CARATTERISTICHE DIMENSIONALI DIMENSIONAL CHARACTERISTICS	ISO 10545-2	-	S > 410	
	LATI SIDES		-	± 0,6%	± 0,2%
	SPESSORE THICKNESS		-	± 5%	± 3%
	RETTILINEITÀ DEGLI SPIGOLI STRAIGHTNESS OF EDGES		-	± 0,5%	± 0,2%
	ORTOGONALITÀ RECTANGULARITY		-	± 0,6%	± 0,2%
	PLANARITÀ SURFACE FLATNESS		-	± 0,5%	± 0,2%
	ASSORBIMENTO D'ACQUA WATER ABSORPTION	ISO 10545-3	-	≤ 0,5%	≤ 0,1%
	RESISTENZA ALLA FLESSIONE BENDING STRENGTH	ISO 10545-4	≠ 12 mm	≥ 35N/mm ²	≥ 40 N/mm ²
			≠ 24 mm	≥ 35N/mm ²	≥ 50 N/mm ² **
	MODULO DI ROTTURA MODULUS OF RUPTURE	ISO 10545-4	≠ 12 mm	> 1.300N (sp. ≥ 7,5mm)	≥ 4000 N
			≠ 24 mm	> 1.300N (sp. ≥ 7,5mm)	≥ 6500 N**
	RESISTENZA ALL'ABRASIONE PROFONDA RESISTANCE TO DEEP ABRASION	ISO 10545-6	-	≤ 175mm ³	≤ 145 mm ³
	COEFFICIENTE DI DILATAZIONE TERMICA LINEARE COEFFICIENT OF LINEAR THERMAL EXPANSION	ISO 10545-8	-	≤ 9x10 6°c 1	≤ 7x10 6°c 1
	RESISTENZA AGLI SBALZI TERMICI RESISTANCE TO THERMAL SHOCKS	-	-	METODO DISPONIBILE AVAILABLE METHOD	RESISTE RESISTANT
	RESISTENZA AL GELO FROST RESISTANCE	ISO 10545-12	-	METODO DISPONIBILE AVAILABLE METHOD	RESISTE RESISTANT
	RESISTENZA ALL'ATTACCO CHIMICO RESISTANCE TO CHEMICAL ATTACKS	ISO 10545-13	-	min. UB	RESISTE RESISTANT
	RESISTENZA ALLE MACCHIE STAIN RESISTANCE	ISO 10545-14	-	METODO DISPONIBILE AVAILABLE METHOD	RESISTE RESISTANT

**Measurements made on the 20x60 cm format.

We produce technical unglazed porcelain stoneware slabs, and some light impurities and dots must be considered as a standard feature of the product.

Coefficient of friction

PORCELAIN SLABS

ISO 13006 - G - BIa UGL (E ≤ 0,5%) UNI EN 14411 - G -

	SUPERFICI SURFACES		SPESSORE THICKNESS	DIN 51130	DIN 51097	BCR	BRITISH PENDULUM BS7976	R9729 UPI/EMPA	DCOF (SECTION 9.6 ANSI A 137.1.2012)	
 COEFFICIENTE D'ATTRITO COEFFICIENT OF FRICTION	CONCEPT 1	BOCCIARDATO ANTISLIP		#12mm #24mm	R11	A + B + C	> 0,40	> 36 WET	GS2/GB1	> 0,42 wet
	INCLUSIONI	SOAVE	BOCCIARDATO ANTISLIP	#12mm #24mm	R11	A + B + C	> 0,40	> 36 WET	GS2/GB1	> 0,42 wet
	MADE 2.0		BOCCIARDATO ANTISLIP	#12mm #24mm	R11	A + B + C	> 0,40	> 36 WET	GS3/GB2	> 0,42 wet
	QUARRY		BOCCIARDATO ANTISLIP	#12mm #24mm	R11	A + B + C	> 0,40	> 36 WET	GS2/GB1	> 0,42 wet

The values of slip resistance and of static and dynamic friction coefficient shown in the catalogue, and in the web site are merely indicative and non-binding. Any possible specific requirement must be confirmed by us at the order and anyway always before the installation.

OUTDOOR2021

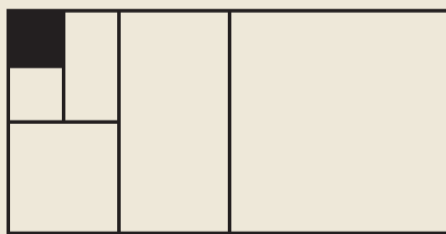

GIGACER®

GIGACER SPA
VIA CALTAGIRONE, 72
48018 FAENZA (RA) ITALY
TEL. +39 0546 637110
FAX +39 0546 637 127
WWW.GIGACER.IT